

LifeSmart云起

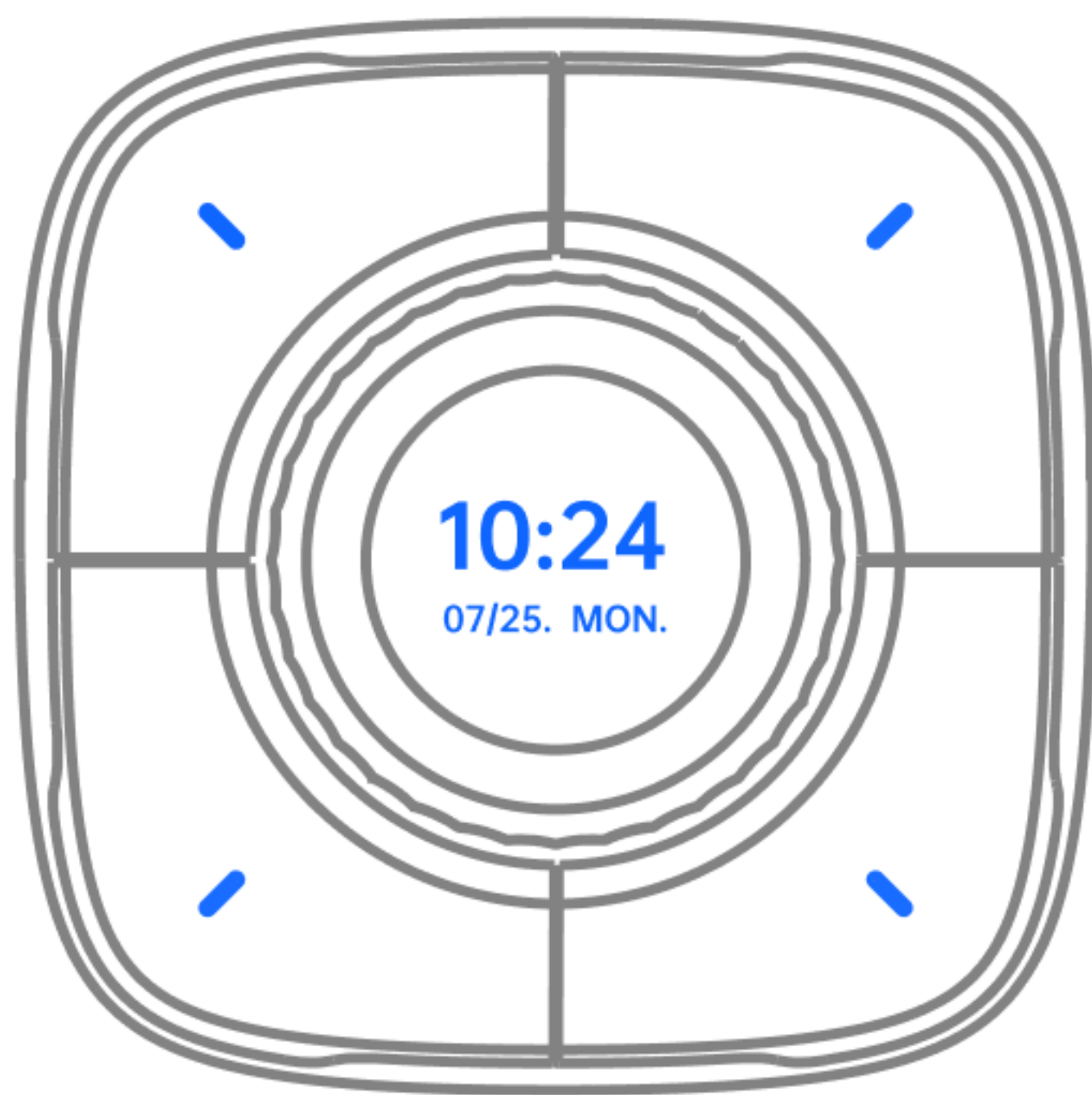

Nature X

User Manual **V1.0.3**

Software Version.V1.0.0p107

Nature X gestures

Welcome to Nature X, with a Ring and four Physical Keypads. You can use several basic gestures to interact with Nature X.

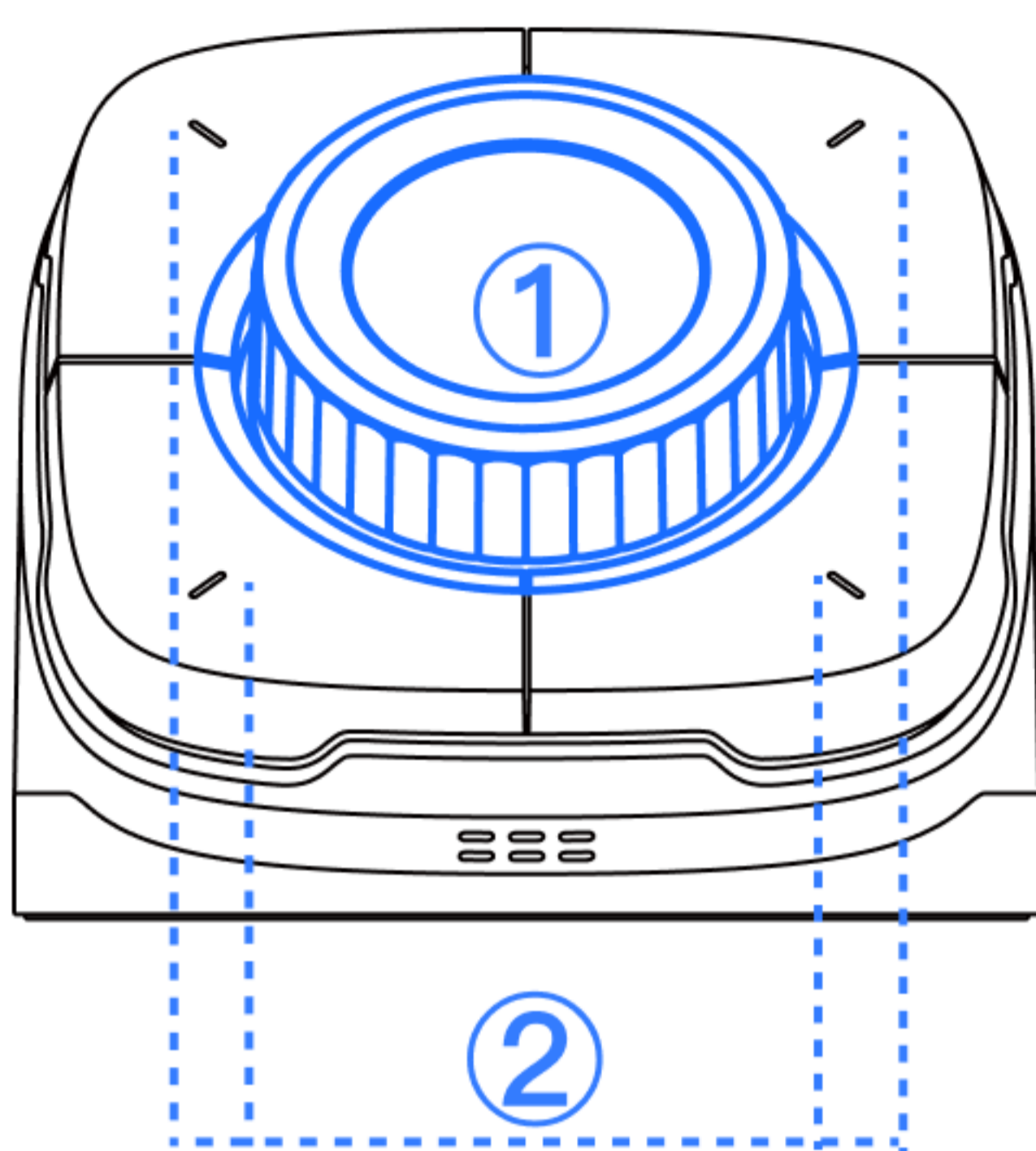

① Ring

| Gesture | Function |
|-------------------------|--|
| Short press | Screensaver to Favorite Select OK For device/application, see the specific instructions page |
| Clockwise rotation | Next Increase value Cooler Color |
| Anti-clockwise rotation | Previous Decrease value Warmer Color |

② Keypads

| Interface | Matching functions |
|------------------------|---|
| Screensaver | Custom keypads function |
| Device/ Application | Top left: Back Top right: Menu/Function Lower right: Function Lower left: Function |
| Favorite/ Setting | Top left: Back Top right: Confirm Lower right: Next Lower left: Previous |

LED light effect

Nature X's LED Ring and Keypads LED
LED will indicate different light effects
in different functions

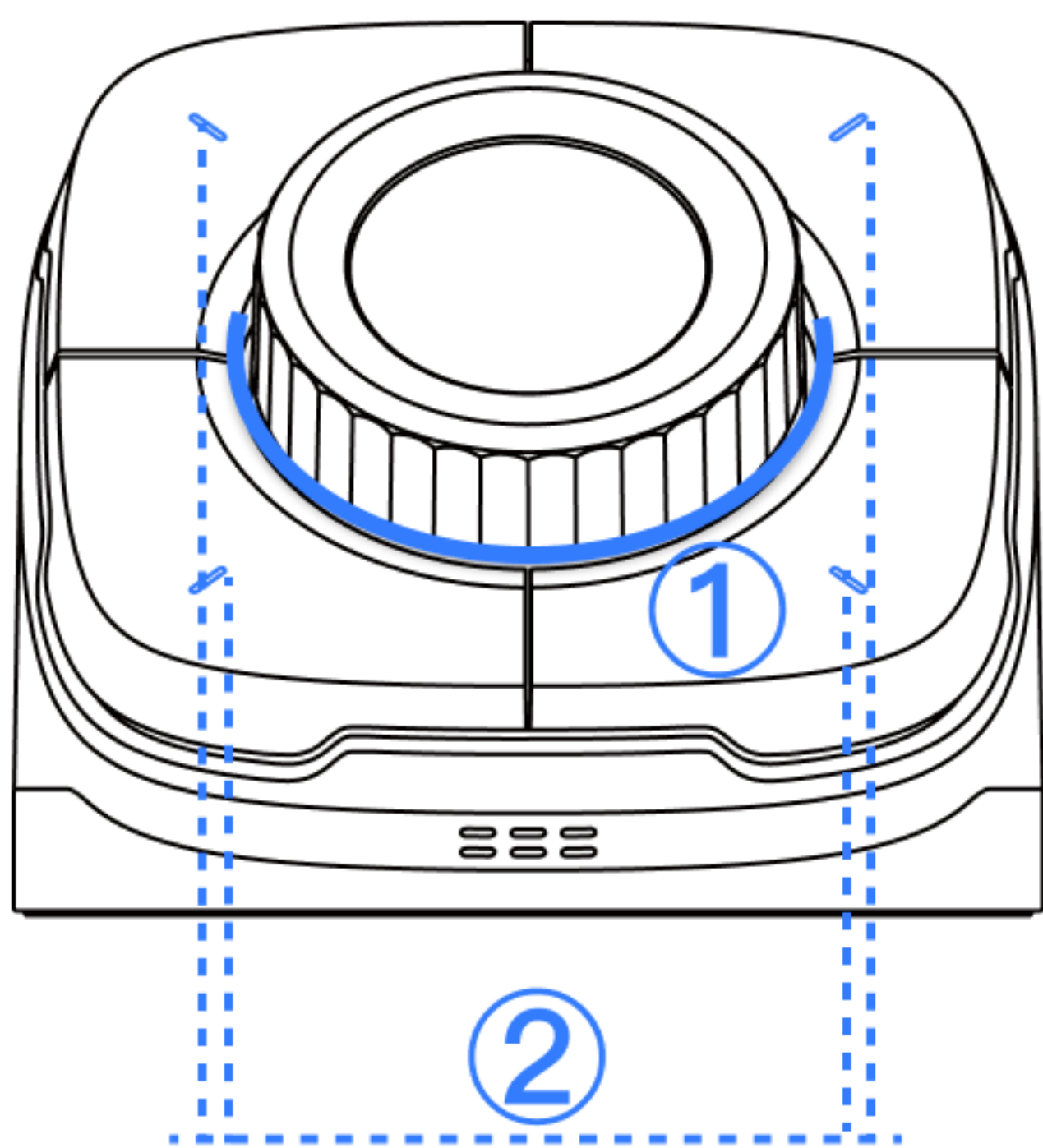

① LED Ring

| Effect | Function/state |
|------------------------------|----------------|
| Green-blue breath 3 times | Launch |
| Orange-red gradient | Alarm |
| Blue-white constant light | Screensaver |

② Keypads LED

| Effect | Function/state |
|----------------------|------------------|
| Blue | Back |
| Green | Confirm |
| Pink | Cancel |
| Cyan | Function keypads |
| Pink (on) Cyan (off) | Switch Status |
| White | Custom keypads |
| Off state | No function |

Get Started

It takes just a few minutes to get up and running with Nature X. You need to do some basic setup, follow the boot wizard, select language and time zone, connect to the network, and add this Nature X to LifeSmart APP

① Connect to the network

Boot Wizard >> Network
Setting >> System >> Network

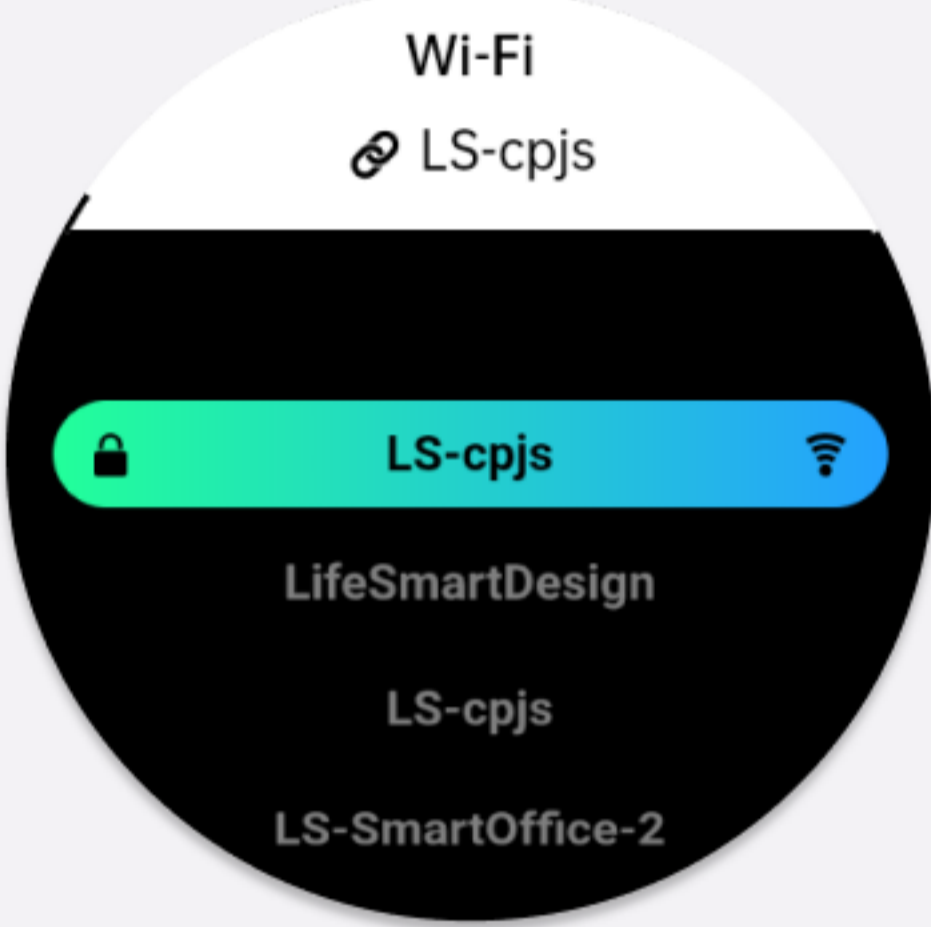

★ Tips – Keyboard

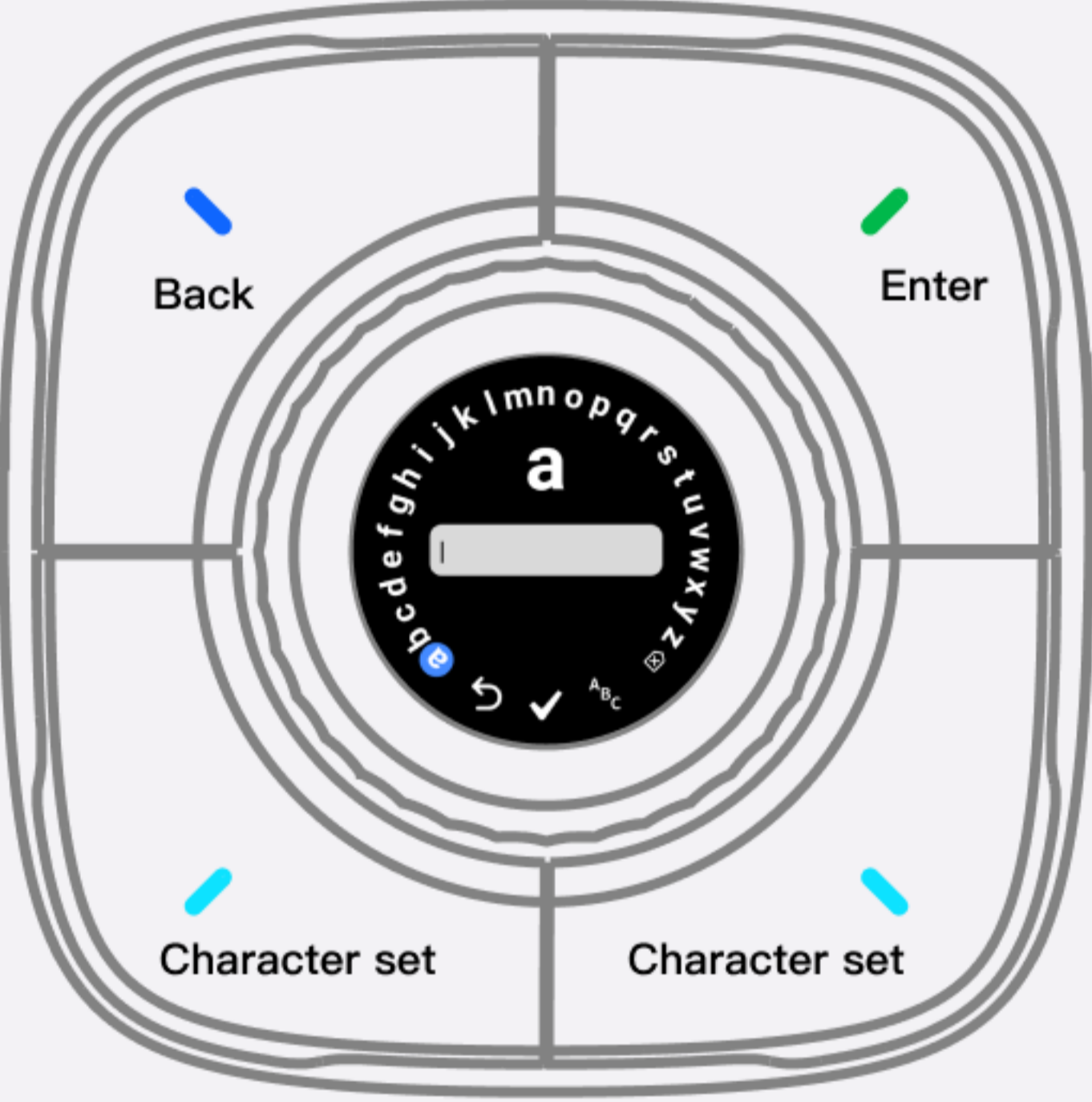

Rotate to select
Press to enter



Delete



Character set



Submit

③ Add device

To control smart devices, add or configure your smart devices to Nature X first

★ Tips – Add a device

Follow the instructions of the device to be added and put the device into pairing status. There are two ways to add a new device

[Add a device via Nature X]

- 1.Devices >> Add Device >> LifeSmart Device
- 2.Start pairing
- 3.Follow the guide to complete the new device addition

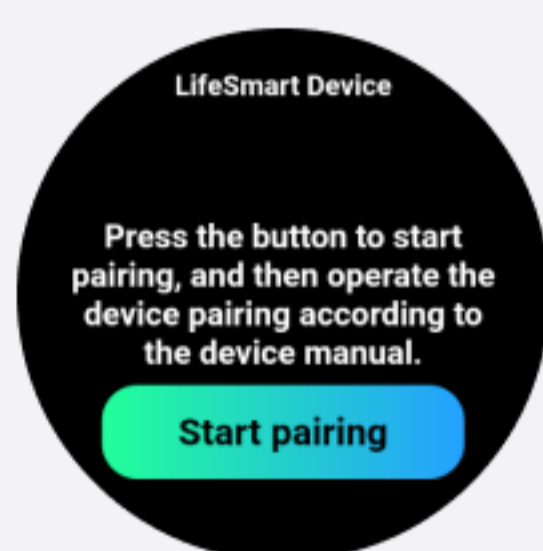
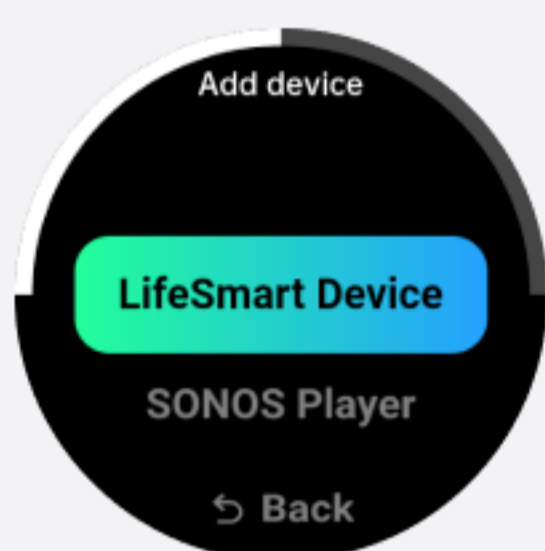

[Add a device via the LifeSmart App]

- 1.Download LifeSmart App and register the account
- 2.Click "+" on the top right corner and select "Add Device", click "The device you want to add".
- 3.Select "Nature X" as the Smart Station
- 4.Follow the app guide to complete the new device addition

At this time, the LifeSmart smart device will be successfully added to your LifeSmart account and Nature X. You can configure it to [Keypads] and [Favorite] in Nature X

★ Tips – Add devices across Local Smart Station

- Keep Nature X and the other smart station under the same LAN, and select the local smart station when configuring [Keypad] or adding [Favorite], you can add devices and scenes from the local smart station to Nature X



★ Tips – Add SONOS Player

Keep Nature X and the SONOS Player under the same LAN. There are two ways to add the SONOS Player

[Add SONOS via Nature X]

- Devices >> Add Device >> SONOS Player

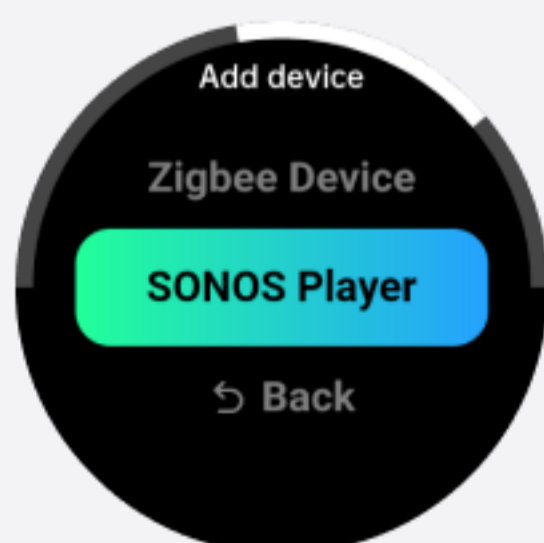
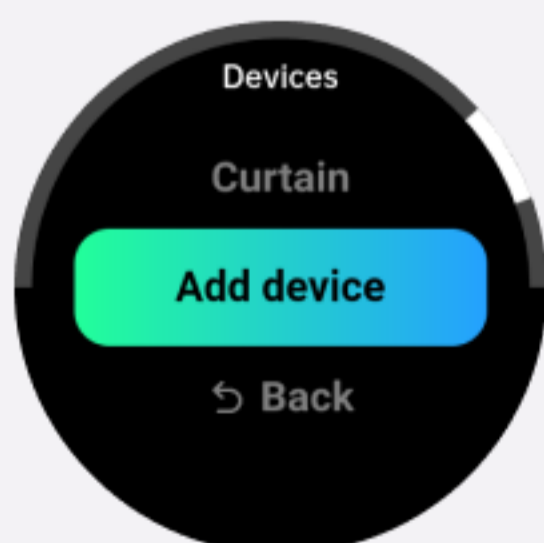

[Add SONOS via LifeSmart APP]

- 1.Add Device >> Music >> SONOS Player
- 2.Select Nature X as the Smart Station
- 3.Select the searched SONOS device
- 4.Add successfully

After that, this SONOS Player has been successfully added to your account and Nature X. You can configure it to [Keypad] and [Favorite] in Nature X

Interface & Functions

Nature X has four main types of interface, screensaver, Favorite list, device/application, and settings. And you can switch flexibly between these four interfaces with the Rings and Keypads

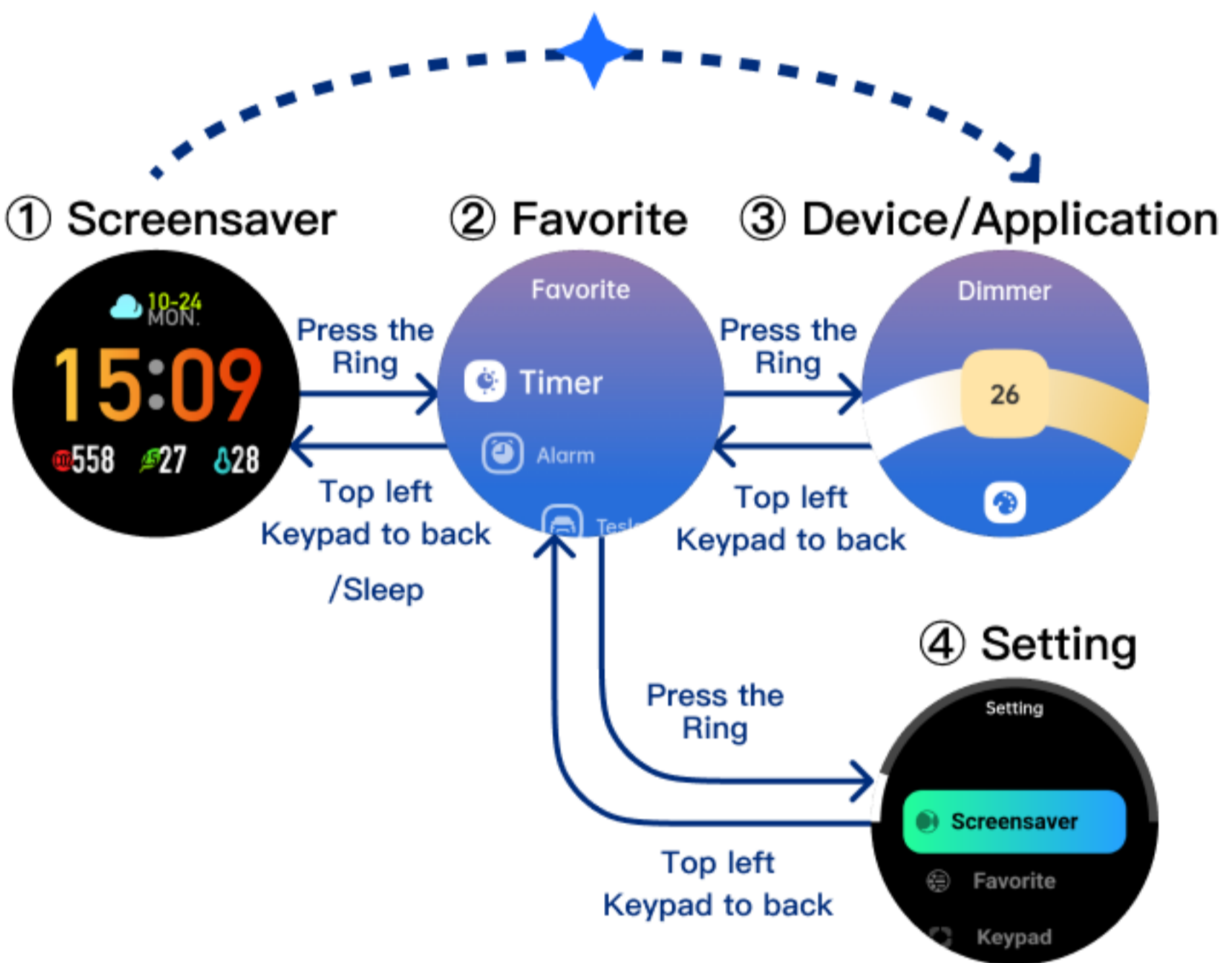

★ Tips – Screensaver to devices/ applications

①→③

- Configure the device/application page for the Keypads under the screensaver
- The system will recommend some special screensavers, at this time press the Ring to enter the relevant device/application page, such as Timer/Sonos/Tesla

① Screensaver

Set screensavers

Nature X supports several screensavers, rotate the Ring to switch, press the Ring to exit the [Screensaver] to [Favorite]

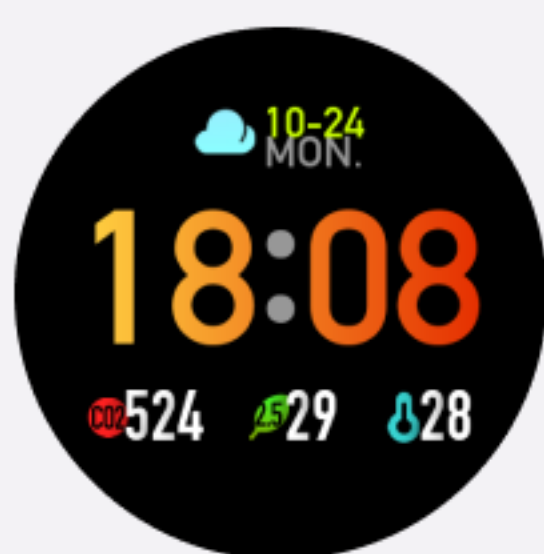

Clock display



Weather



Air Quality



Temp&RH



Tesla

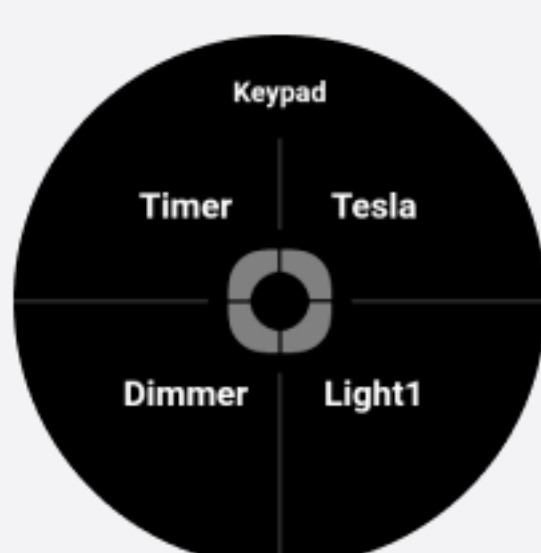

Keypad

★ Tips – Screensaver Setting

- In Setting >> Screensaver, you can customize the screensaver, add or remove them, adjust the style, and adjust the order
- Some screensavers support different styles, e.g., the Clock display >> Style

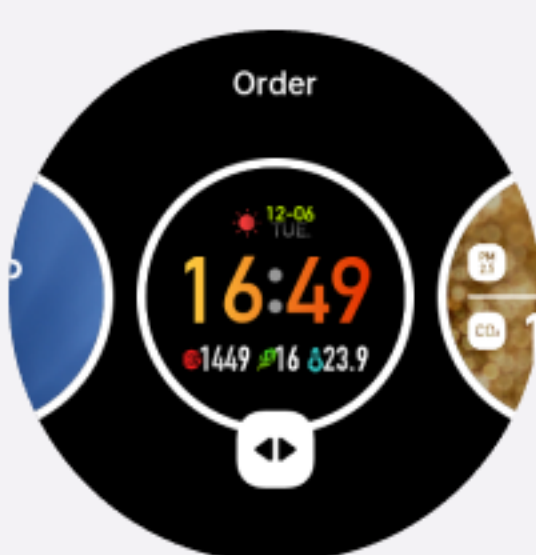

Reorder

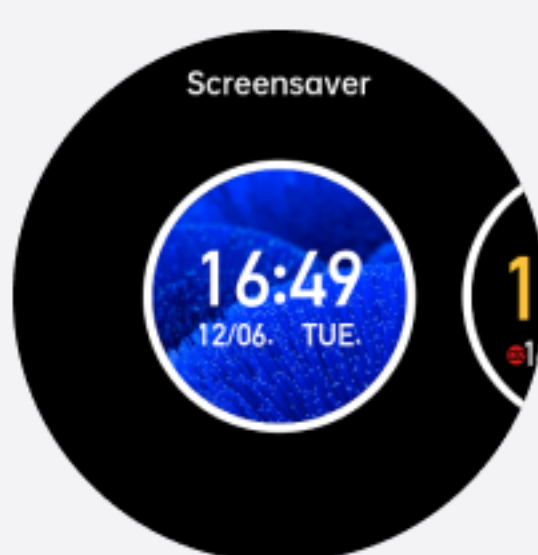

Style

★ Tips – CO2 concentration range

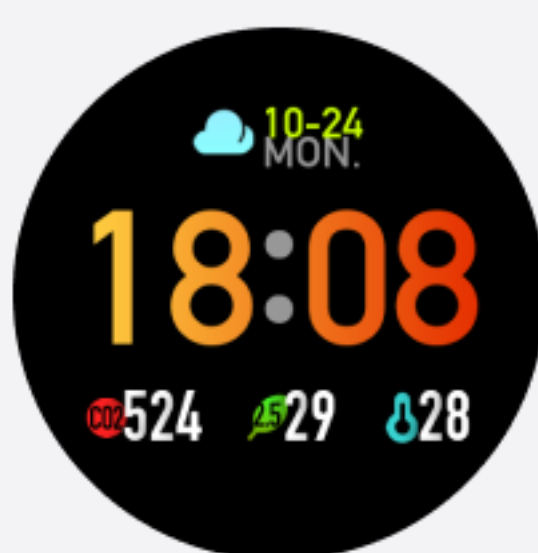

Concentration (ppm)

Quality

≤ 800

Excellent/A

Fresh air, comfortable space

800 < ≤ 1000

Good/B

Good air, smooth breathing

1000 < ≤ 1200

Fair/C

Feel dull, easy to discomfort

> 1200

Poor/D

Insufficient oxygen, sleepy, time to ventilation

System Screensavers

When you are counting down or playing music. The system will recommend relevant special screensavers, at this time press the Ring to enter the relevant device/application

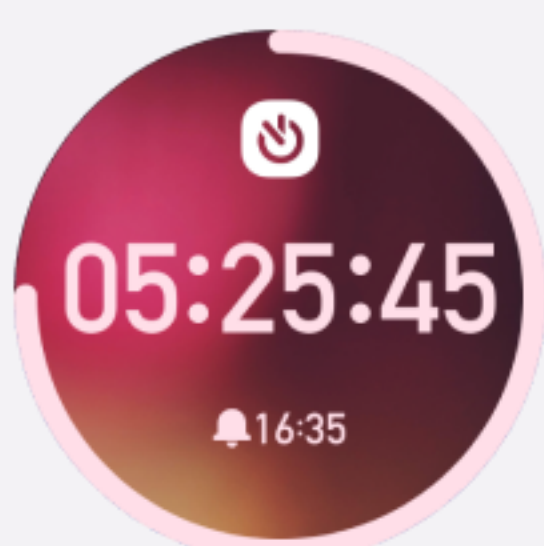

Timer

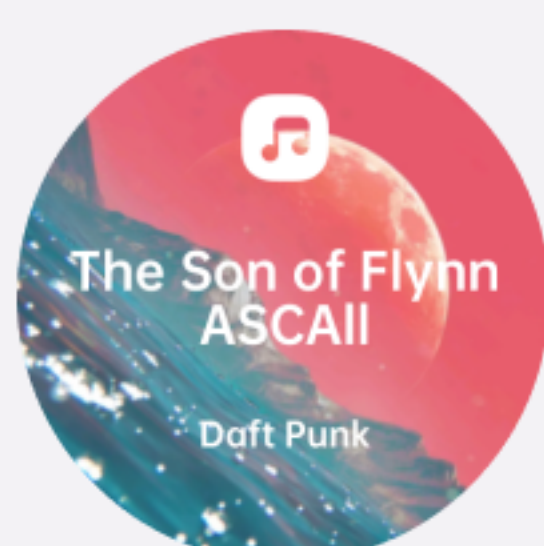

SONOS

Keypad

These four physical keypads can be configured with custom functions under [Screensaver]

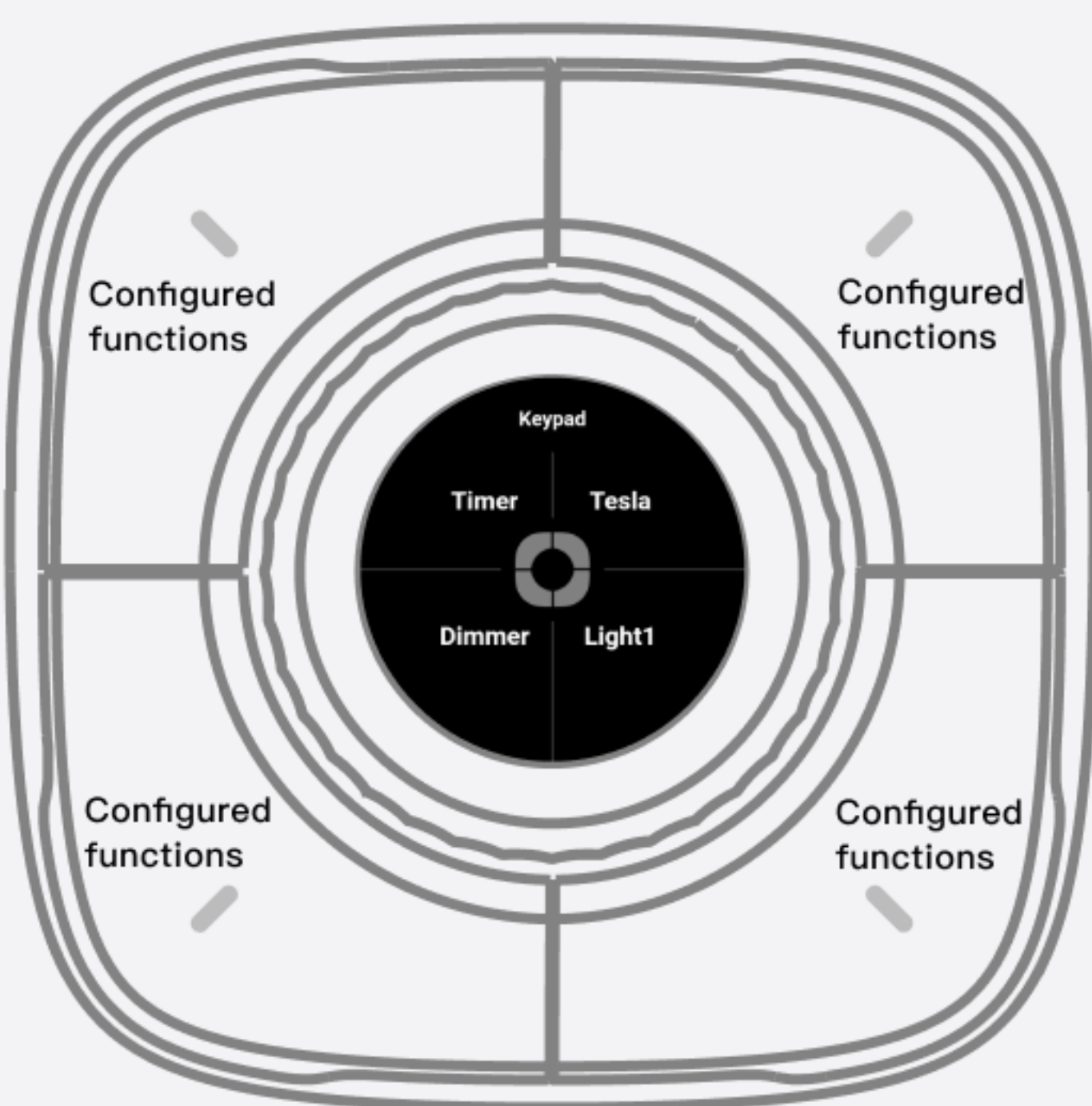

★ Tips – Keypads Setting

- In Setting >> Keypad, you can configure the application, device and scene to the keypad
- When configuring devices or applications, you can quickly go to the relevant device or application page
- When configuring smart scenes/switch IO, you can quickly control them

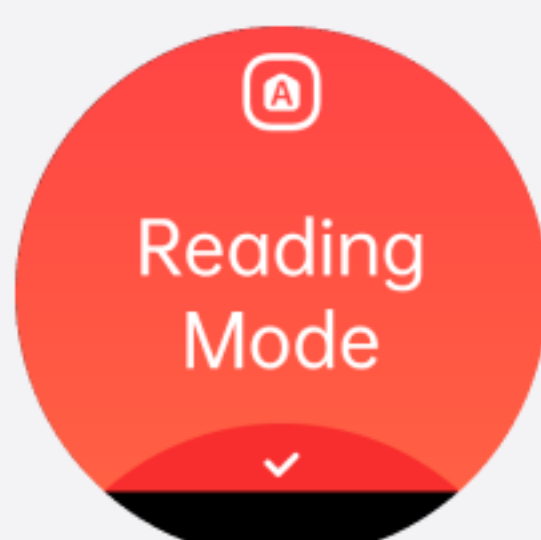
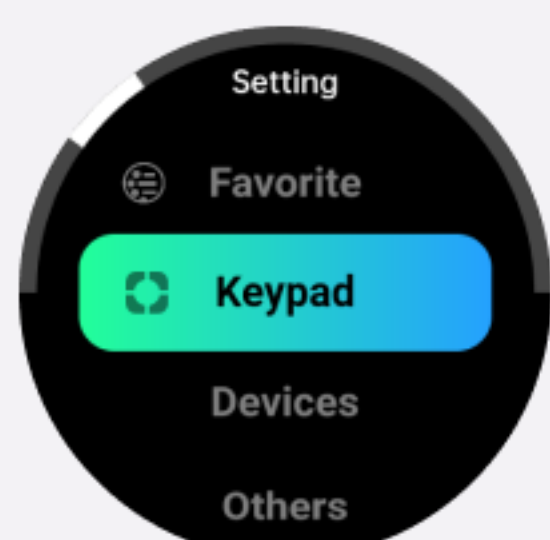

② Favorite

We have added Tesla, Alarm, and Timer in the [Favorite] for you by default.

- You can press the upper left button to back to the [Screensaver]. Or wait for system sleep automatically (default sleep time is the 30s).
- Press the Ring to enter the device/application.

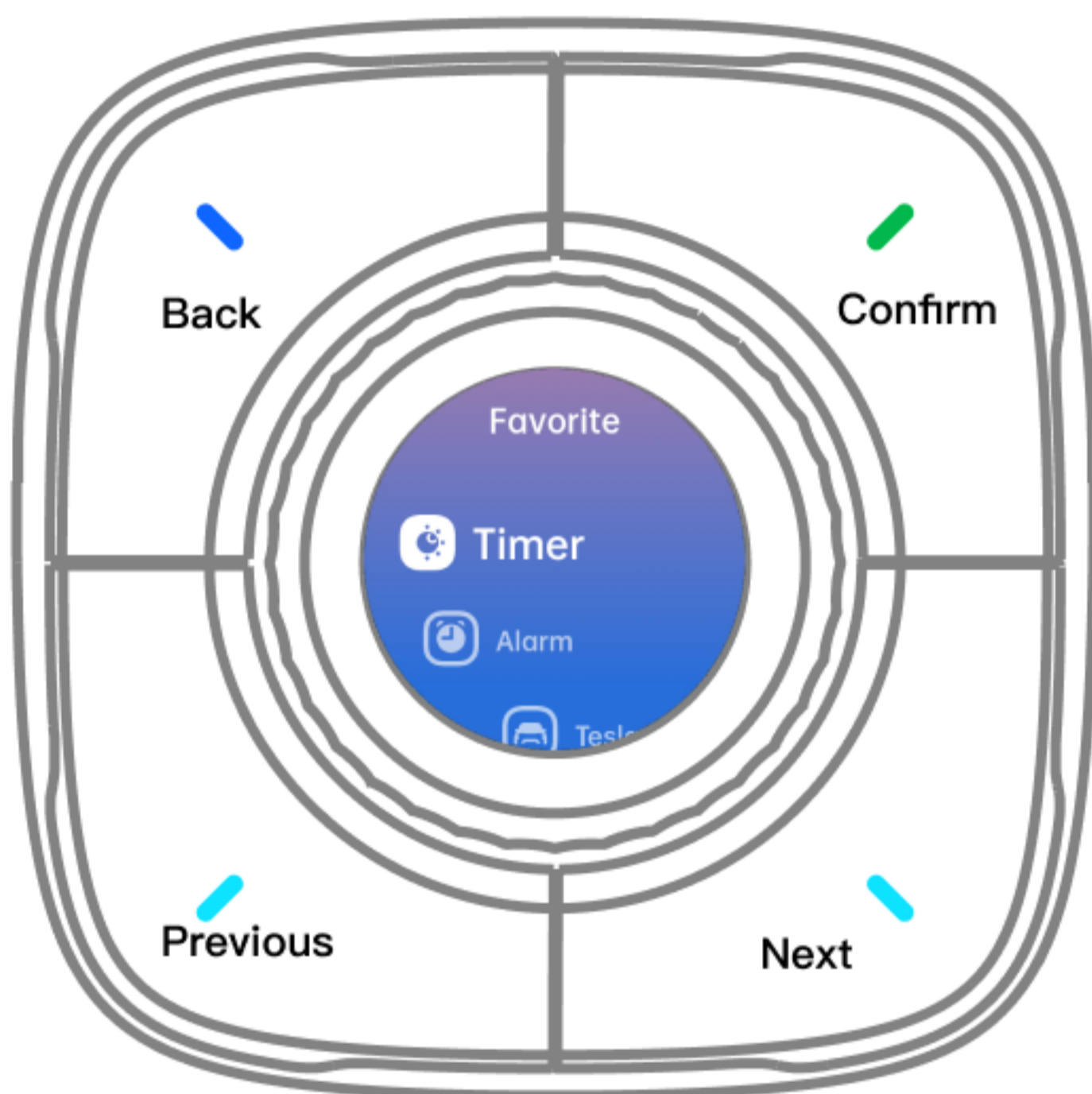

★ Tips – Favorite setting

In Setting >> Favorite, you can customize your Favorite list, add or delete devices and applications, and adjust the order

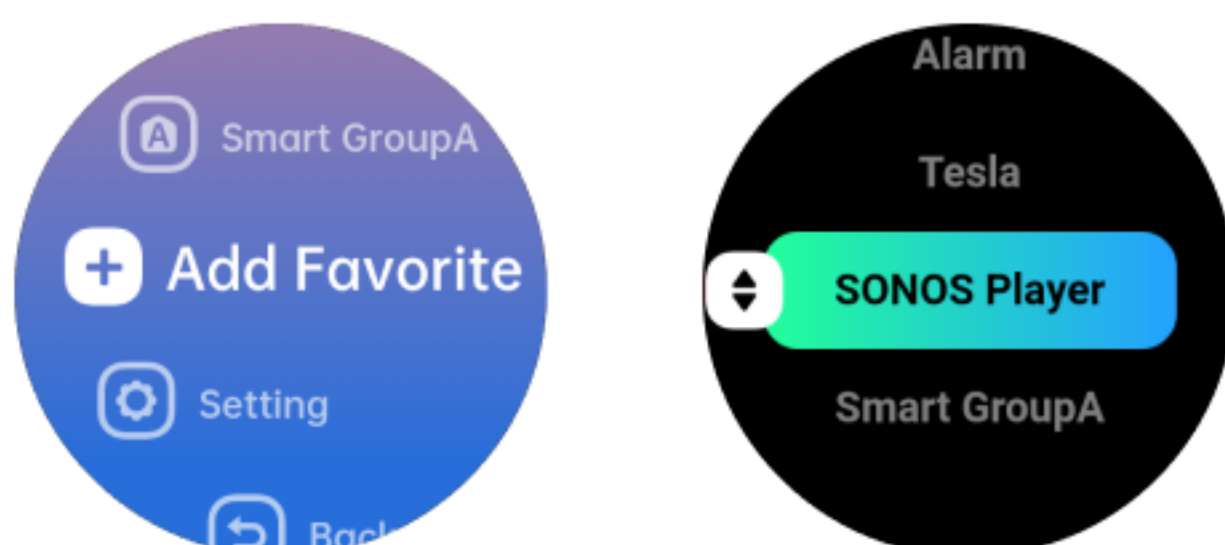

③ Device/Application

Tesla

Check the remaining mileage and battery of your Tesla, the temperature inside and outside, and quickly control the air conditioning on/off

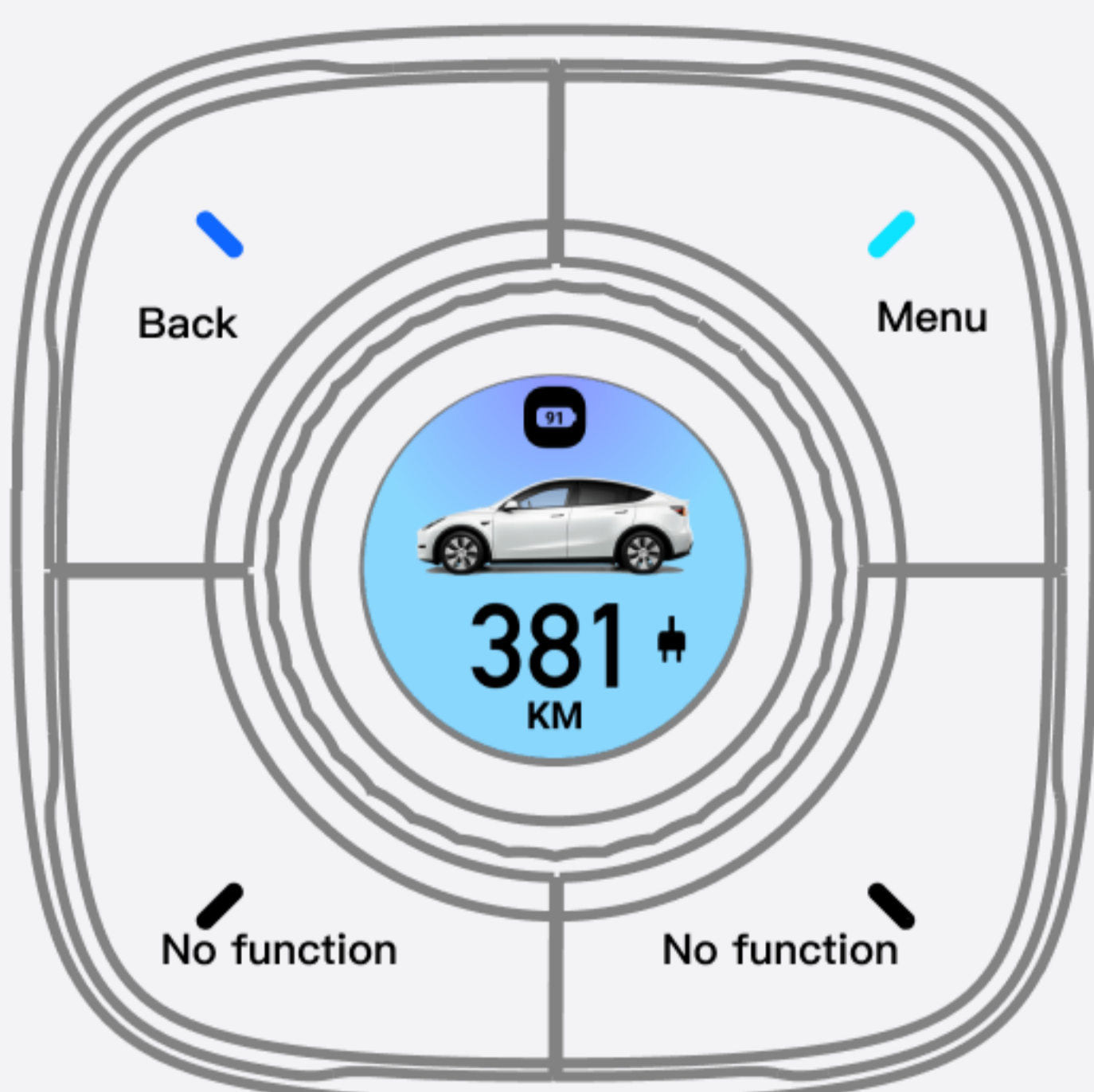

Operation

Press the Ring

Rotate the Ring

Top left Keypad

Upper right Keypad

Lower right Keypad

Lower left Keypad

Function

Turn Air con ON/OFF

MI/temperature

Back

Menu

No function

No function

★ Tip – Login

- Please use the latest LifeSmart APP to scan the QR code on the screen or use the keyboard in Nature X to login.
- Enter the menu, you can switch car and logout

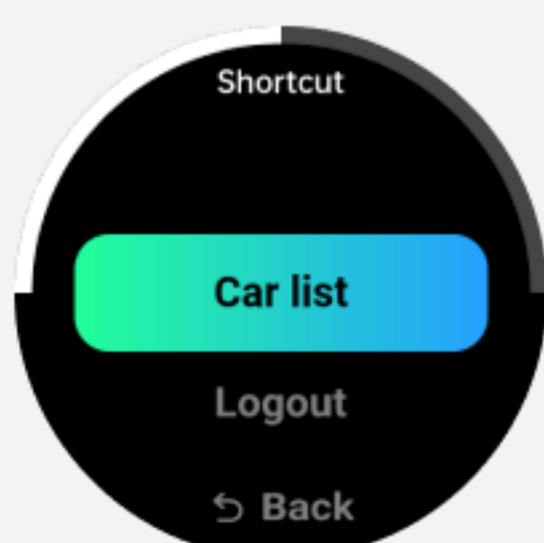
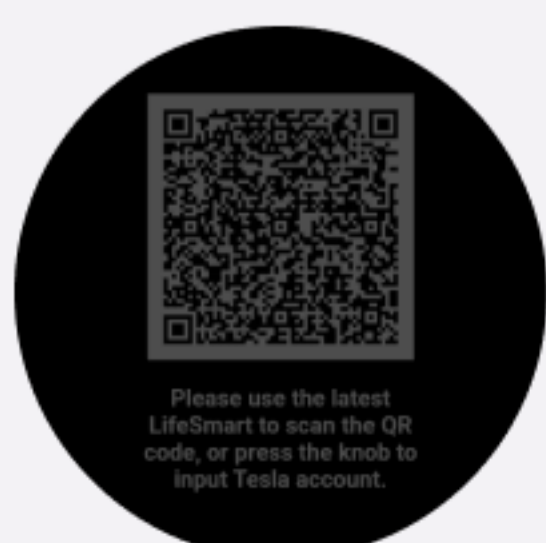

Timer

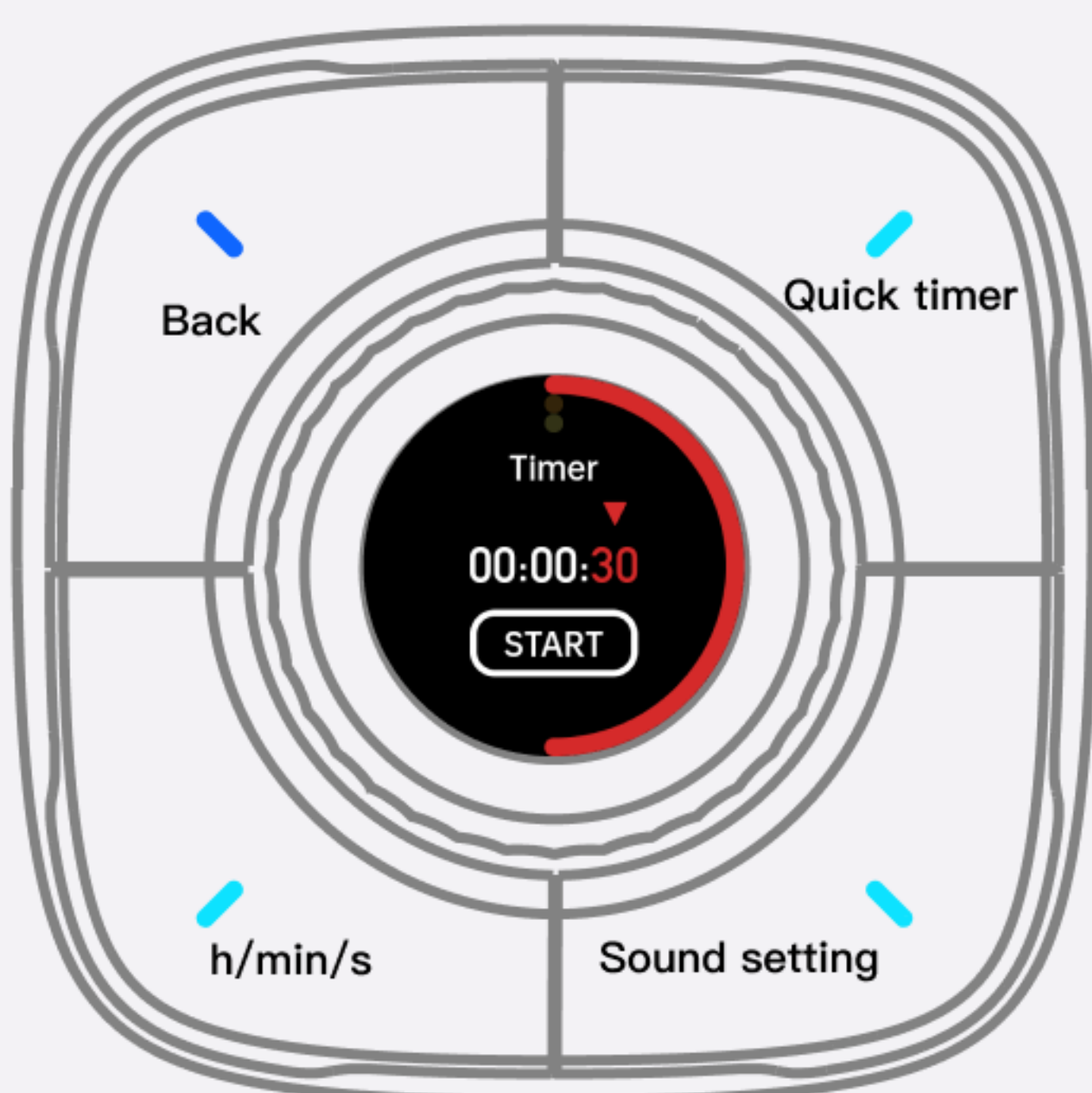

Operation

Press the Ring

Rotate the Ring

Top left Keypad

Upper right Keypad

Lower right Keypad

Lower left Keypad

Function

Start/pause countdown

Adjust time

Back

Quick timer

Sound setting

h/min/s

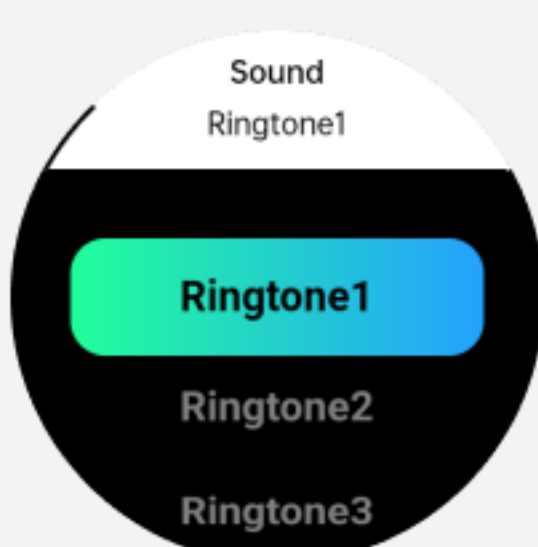
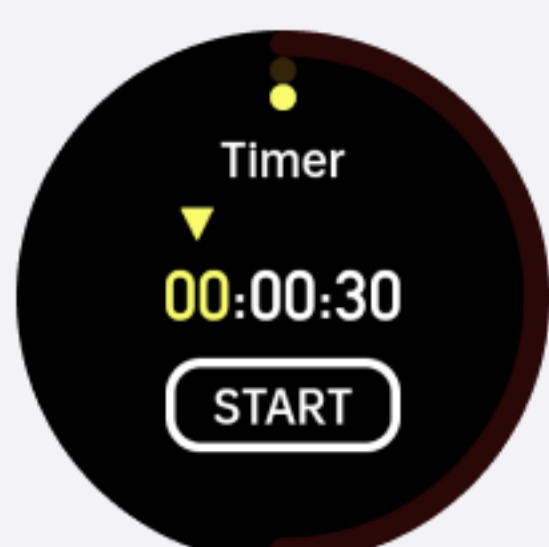

★ Tips – Cancel the countdown

When you are in the process of counting down, you can cancel the current timer by pressing the upper right keypad on the countdown page

★ Tips – Countdown screensaver

When you are in the process of counting down, after entering the screensaver, the system will default to display the countdown screensaver at the top, at this time, press the Ring to quickly to the SONOS music page

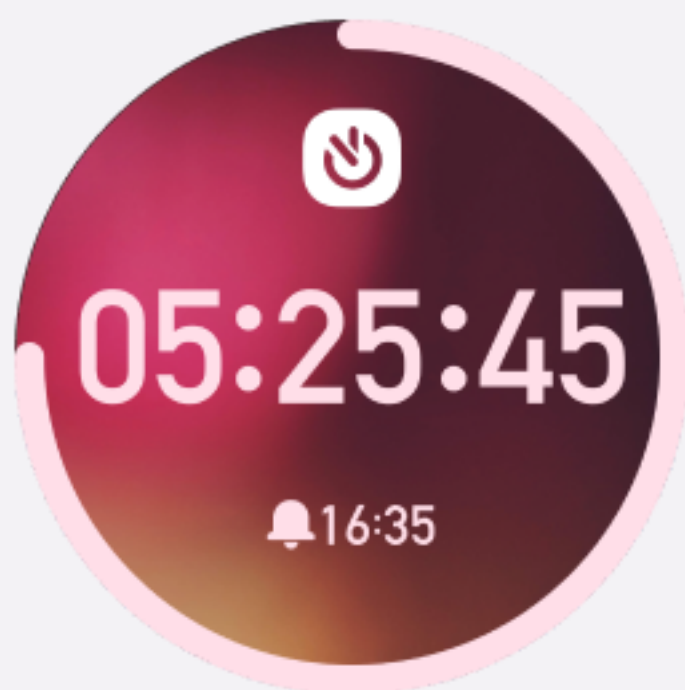

Alarm



Alarm List

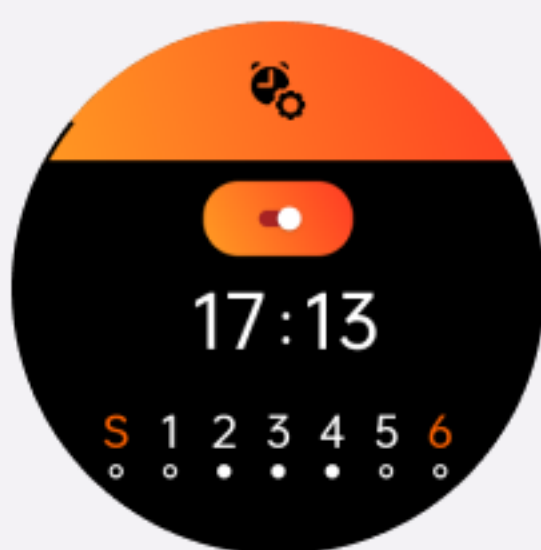

Edit an alarm

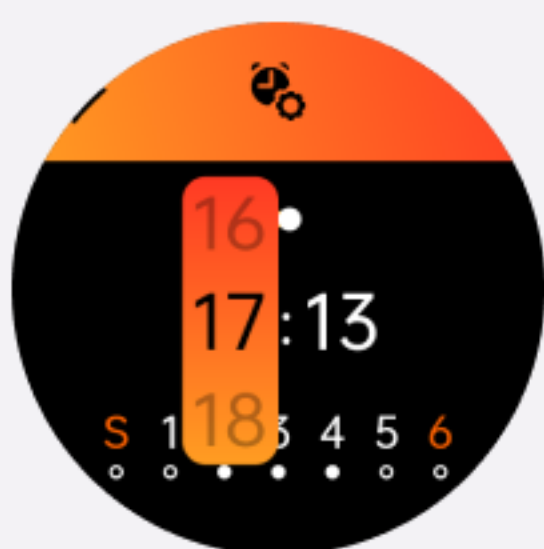

Time Setting

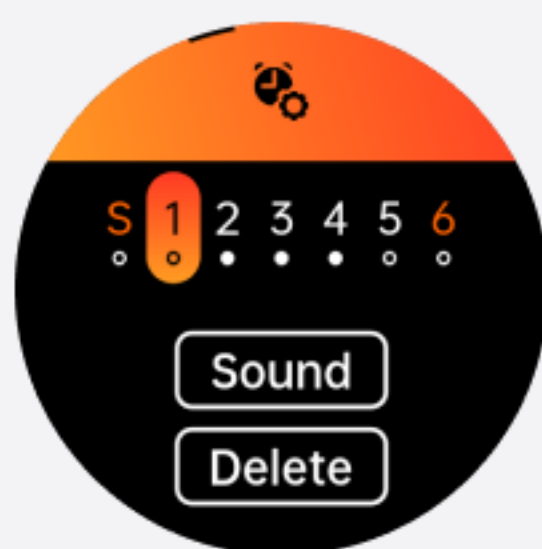

Repeat Setting

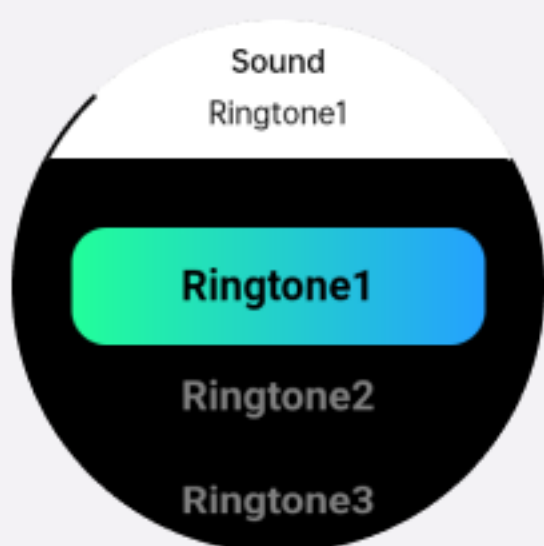

Sound Setting

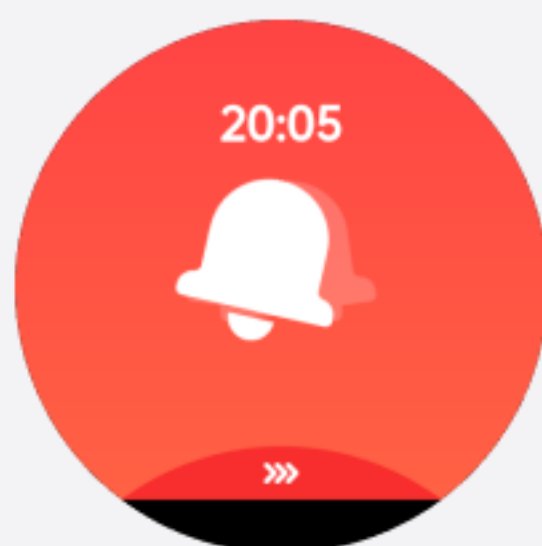

Alarm

★ Tips – Snooze alarm

When the alarm goes off, press the Ring to enter snooze mode, the current alarm will go off again after 5min. When the snooze alarm goes off again, you need to press the upper right keypad to turn it off

Weight

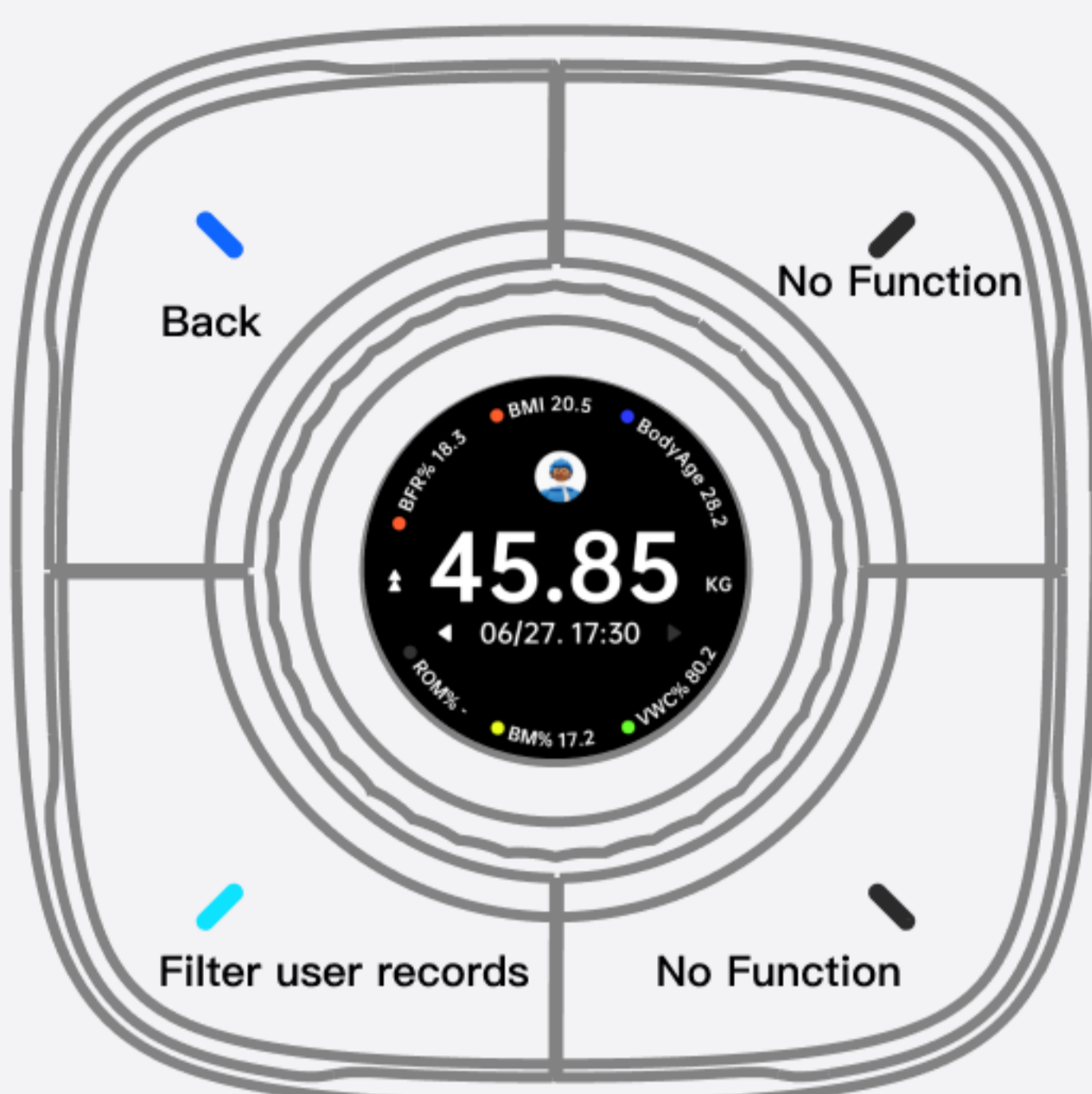

| Operation | Function |
|--------------------|----------------------|
| Press the Ring | Menu |
| Rotate the Ring | Toggle weight record |
| Top left Keypad | Back |
| Upper right Keypad | No function |
| Lower right Keypad | No function |
| Lower left Keypad | Filter user records |

★ Tips – Weight data

- Place the scale and Nature X in the same space (within 10m), stand on the scale and the weight data will be automatically synced to Nature X and recorded
- If you create a user and match your weight data, then Nature X will intelligently determine the user to whom the weighing data is recorded based on existing data

★ Tips – Create User

Create a new user, select your preferred avatar and enter some basic information to complete the user creation

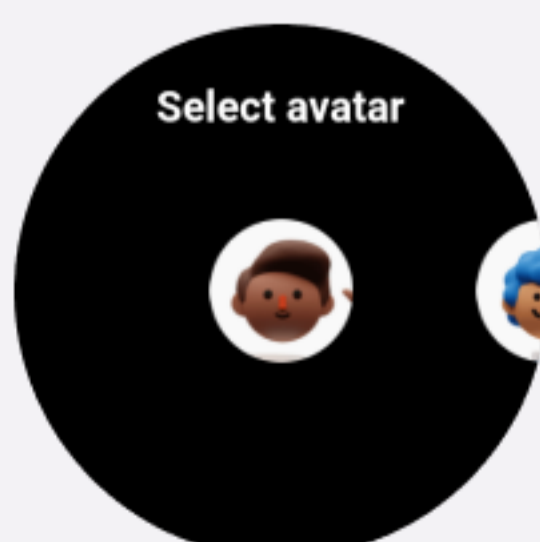
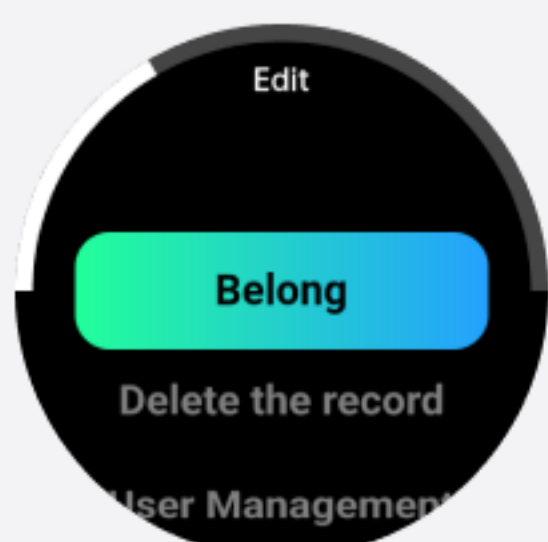

- Supported scales need to be purchased by contacting LifeSmart

SONOS Player

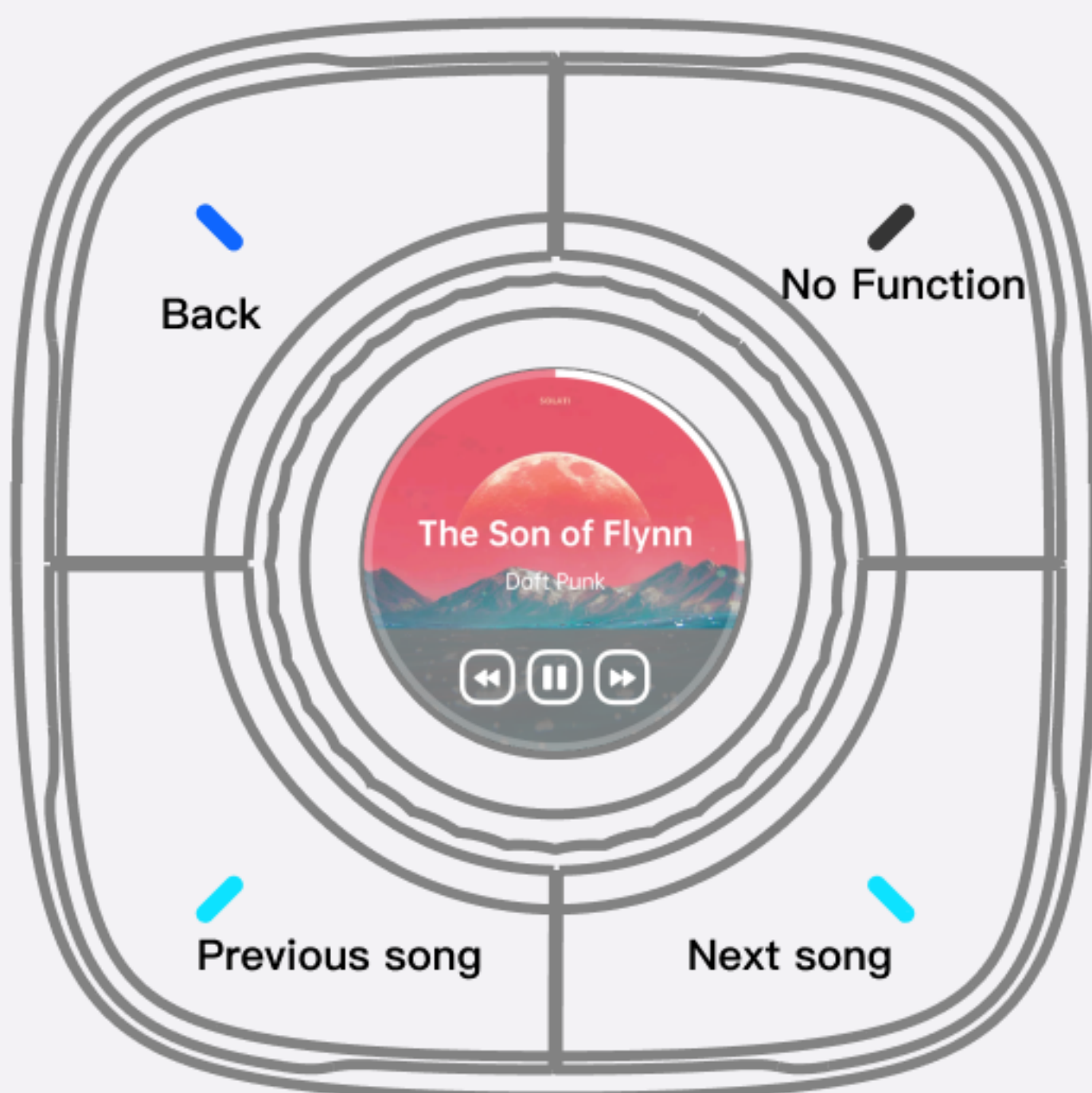

Operation

Press the Ring

Rotate the Ring

Top left Keypad

Upper right Keypad

Lower right Keypad

Lower left Keypad

Function

Pause/Playback

Adjust Volume

Back

No function

Next song

Previous song

★ Tips – Music screensaver

When you are playing music, after entering the screensaver, the system will default to display the music screensaver at the top, at this time, press the Ring to quickly to the SONOS music page

HVAC

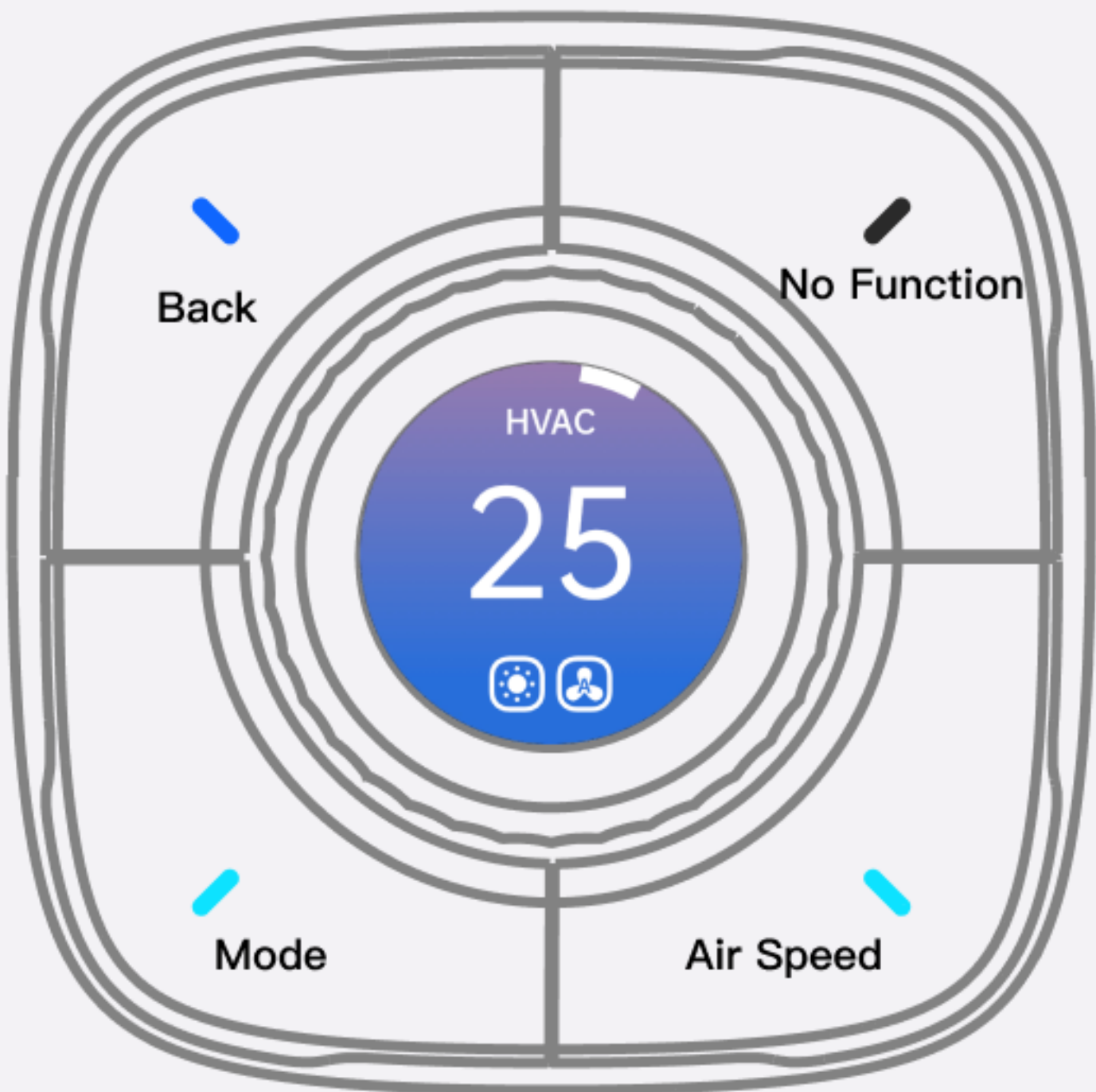

Operation

Press the Ring

Rotate the Ring

Top left Keypad

Upper right Keypad

Lower right Keypad

Lower left Keypad

Function

Turn on/off

Set temperature

Back

No function

Air Speed

Mode

Dimmer

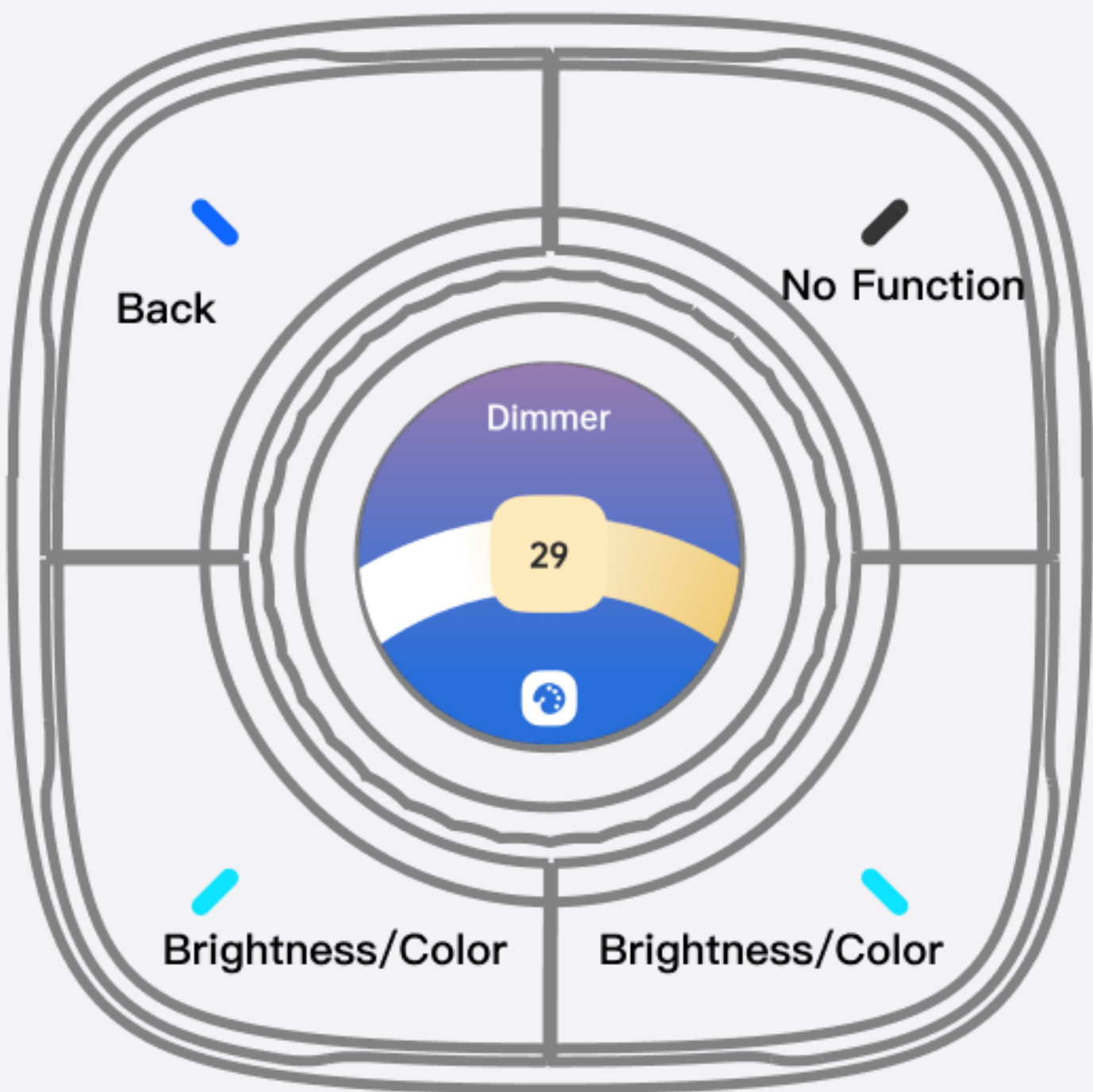

Operation

Function

Press the Ring

Turn on/off

Rotate the Ring

Adjust Brightness/Color

Top left Keypad

Back

Upper right Keypad

No function

Lower right Keypad

Brightness/Color

Lower left Keypad

Brightness/Color

Curtain

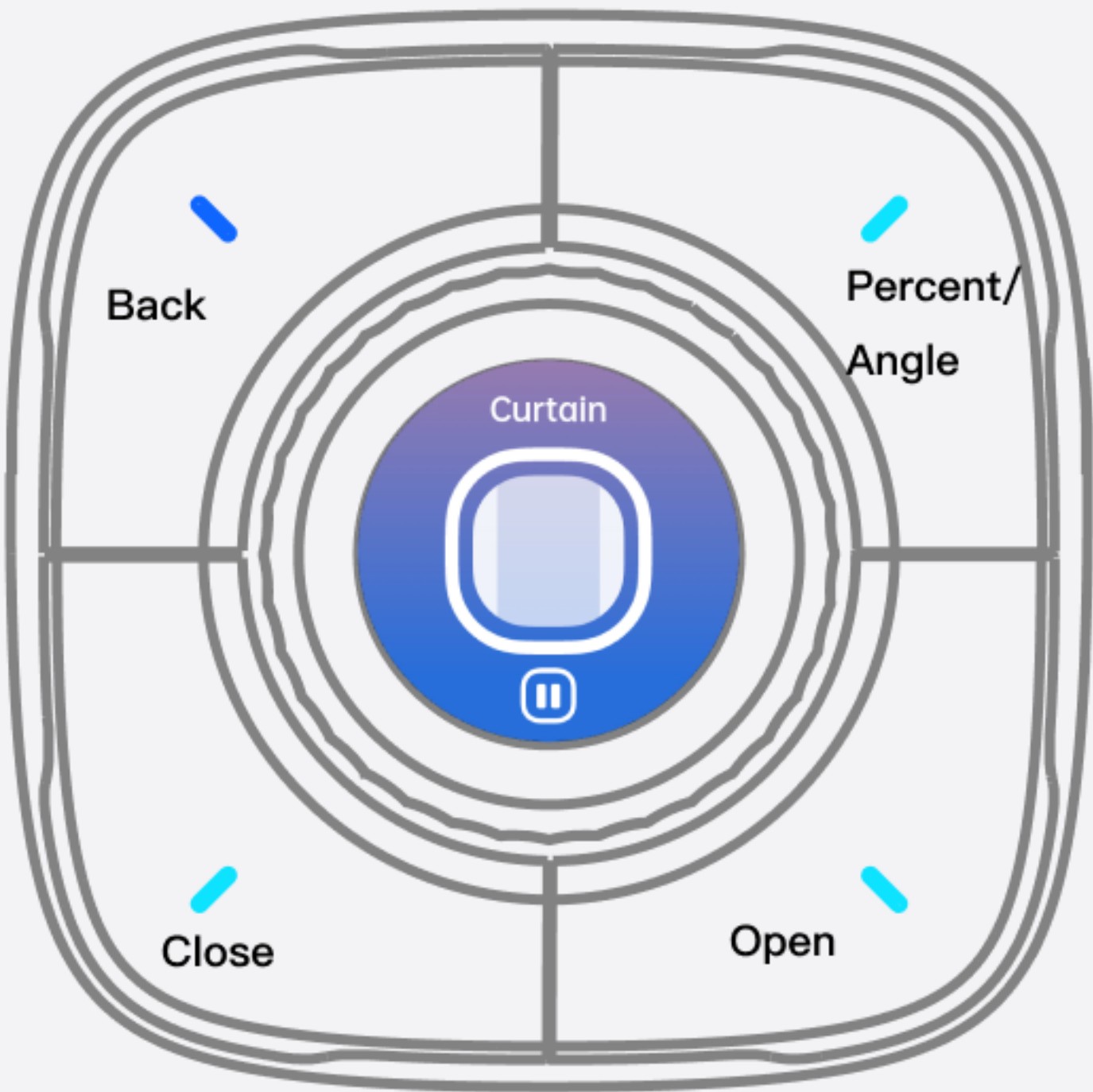

Operation

Press the Ring

Rotate the Ring

Top left Keypad

Upper right Keypad

Lower right Keypad

Lower left Keypad

Function

Pause

Adjust Percent/Angle

Back

Percent/Angle

Open

Close

Switch

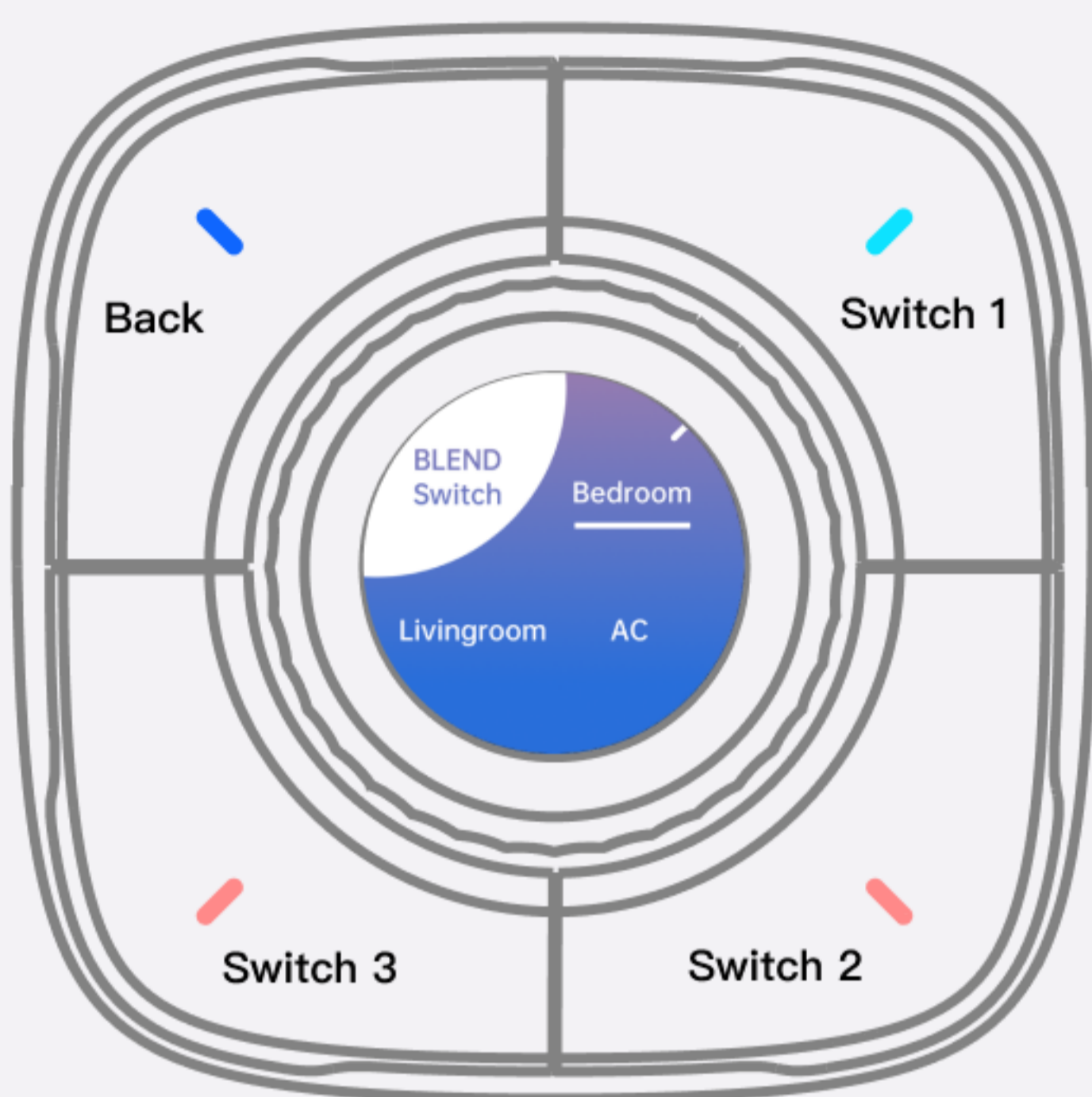

Operation

Press the Ring

Rotate the Ring

Top left Keypad

Upper right Keypad

Lower right Keypad

Lower left Keypad

Function

Turn on/off

Toggle selected Switch

Back

Turn switch on/off

Turn switch on/off

Turn switch on/off

★ Tips – Turn on/off the switch

Press the keypad to quickly turn on/off the switch. In addition to the short white line in the interface, the keypad LED can also show the switch status. When the LED is pink, the light is on, the LED is cyan, the light is off

Smart Group

Smart Group is a custom style that supports controlling multiple devices and scenes on the same page

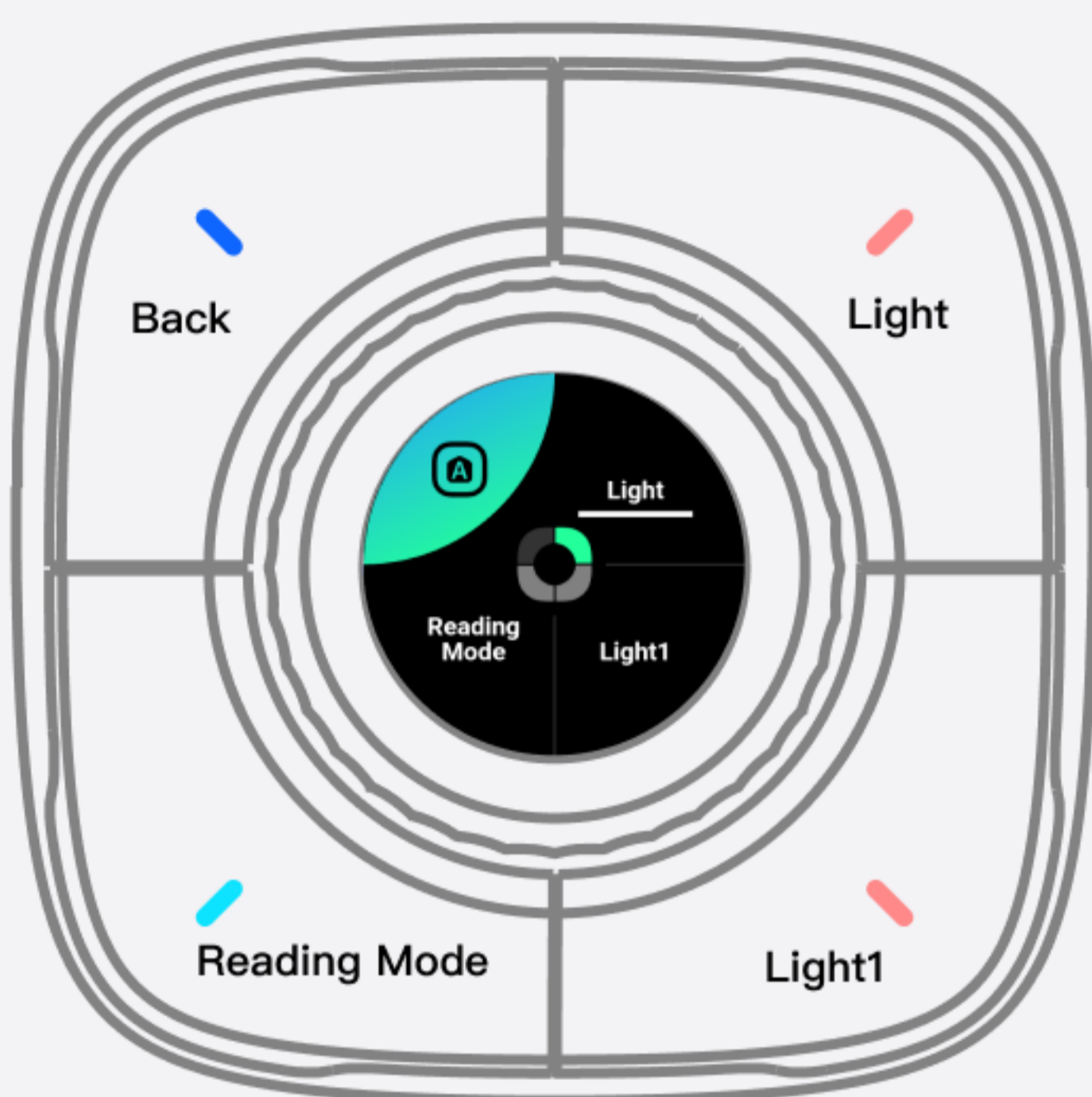

Operation

Press the Ring
Scene control

Rotate the Ring

Top left Keypad

Upper right Keypad

Lower right Keypad

Lower left Keypad

Function

Selected Switch/
Scene control

Toggle selected item

Back

Switch/Scene control

Switch/Scene control

Switch/Scene control

★ Tips – Smart Group

- Smart group can be customized to configure switches/smart scenes
- The suffix number is automatically generated when you create a smart group
- You can configure and modify the number in Setting >> Favorite >> Smart Group

④ Setting

- Configure screensaver, favorite and keypad
- View local device list and applications
- Make other system settings, including time, language, display, volume, etc.

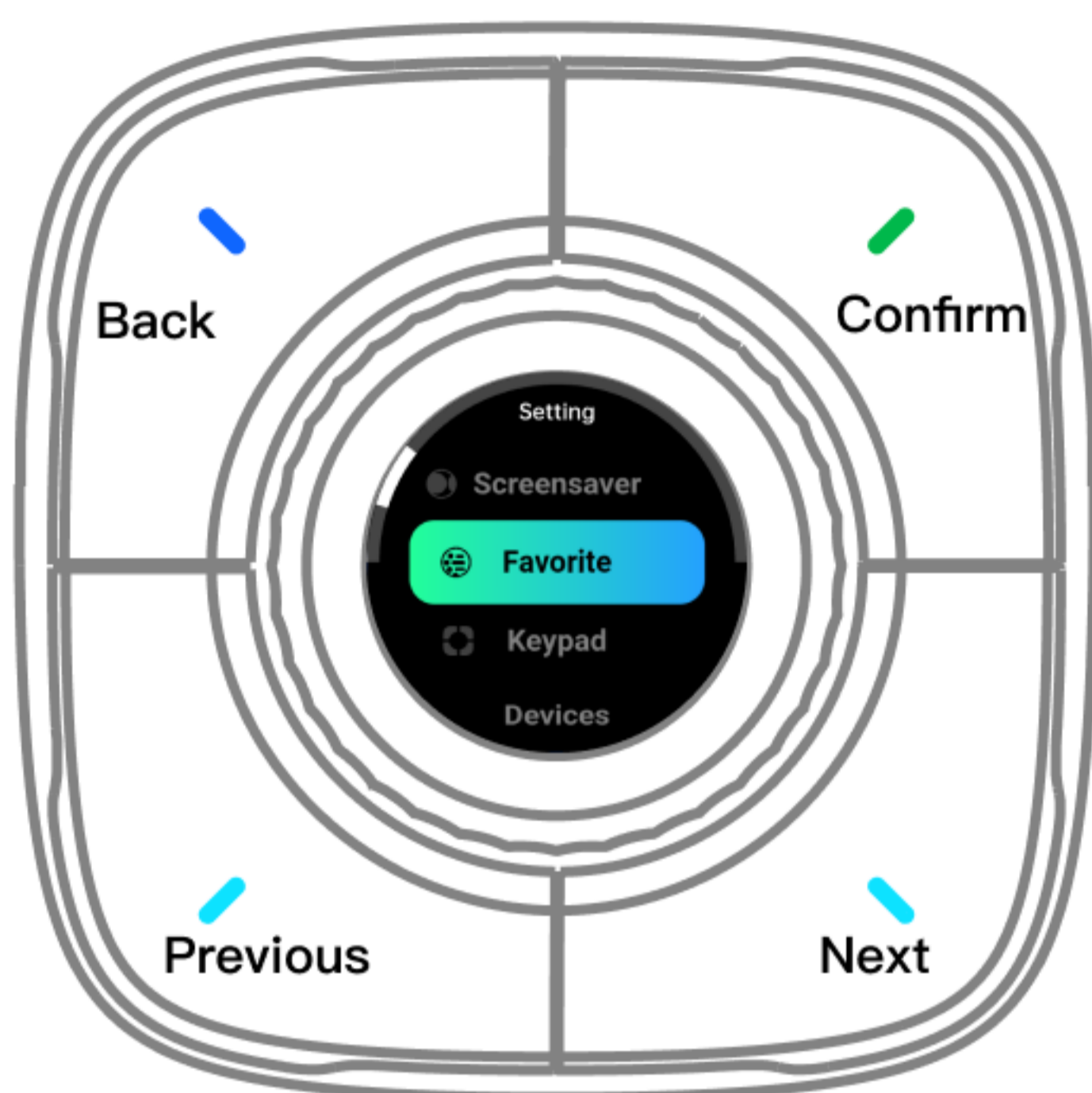

★ Tips – Version Upgrade

The system will check the version update daily and push the relevant upgrade information

A circular screenshot of the 'About' page showing system information. The 'Version' field is highlighted in a blue bar.

| | |
|----------------|-----------------------|
| Version | 1.0.0p114 |
| Smart Station | 1.0.92p50 |
| System version | 1.0.9 |
| Mac Address | a0:9f:10:7e:2c:b2 |
| Device ID | AzgAAF_y4P7_27SE____w |
| IP | 192.168.4.185 |
| In-Voltage | 0.0V (ty:30) |
| QR Code | |
| Send Logs | |

- In Setting>>About>>Version, You can also press the Ring to check the version update
- Please ensure that the network connection and good network quality
- If there is frequent download failure, please remove the weight in [Favorite] first